

Table of Contents

Section 8010 - Traffic Signals		Page No.
Part 1 - General		
1.01	Section Includes	1
1.02	Description of Work	1
1.03	Submittals	1
1.04	Substitutions	1
1.05	Delivery, Storage, and Handling	1
1.06	Scheduling and Conflicts	1
1.07	Special Requirements	2
1.08	Measurement and Payment	2
Part 2 - Products		
2.01	Underground	3
2.02	Detection	6
2.03	Communications	8
2.04	Cabinet and Controller	9
2.05	Poles, Heads, and Signs	11
Part 3 - Execution		
3.01	Underground	15
3.02	Detection	19
3.03	Communications	20
3.04	Cabinet and Controller	20
3.05	Poles, Heads, and Signs	21
3.06	Temporary Traffic Signal	21
3.07	Surface Restoration	21
3.08	Testing	22
3.09	Documentation	22

Section 8010 - Traffic Signals (Continued)**Figure No.****Figures**

Cabinet Footing Details	8010.101
Pole Footing Details	8010.102
Conduit and Handholes	8010.103
Inductive Loop Vehicle Detectors	8010.104
Mast Arm Pole Details	8010.105
Pedestal Pole and Pedestrian Post Details	8010.106
Wood Post Span Assembly	8010.107

TRAFFIC SIGNALS**PART 1 - GENERAL****1.01 SECTION INCLUDES**

- A. Underground
- B. Detection
- C. Communications
- D. Cabinet and Controller
- E. Poles, Heads, and Signs

1.02 DESCRIPTION OF WORK

This part of the specifications includes the furnishing of all material and equipment necessary to complete, in place and operational, traffic control signal(s) as described in the project plans.

1.03 SUBMITTALS

Follow the General Provisions (Requirements) and Covenants as well as the additional requirements listed below. All of the following must be submitted within 30 days after awarding of the contract for the project. Verify the method of submittal with the Jurisdiction.

- A. Schedule of Unit Prices:** Submit a completed schedule of unit prices. Estimates of the work performed on the project will be made by the Jurisdiction and the unit costs will be used to prepare progress payments to the Contractor.
- B. Material and Equipment List:** Submit a completed list of materials and equipment to the Jurisdiction for written approval before any equipment or materials are ordered.
- C. Contractor Certification:** Submit the name(s) and contact information of the International Municipal Signal Association (IMSA) Level II Certified Traffic Signal Technician(s) working on the project and a copy of their IMSA certificate.
- D. Shop Drawings:** Submit shop drawings for traffic signal poles and structures to be furnished on the project. Submit catalog cuts and manufacturer's specifications for all items in the equipment list.

1.04 SUBSTITUTIONS

Comply with Division 1 - General Provisions and Covenants.

1.05 DELIVERY, STORAGE, AND HANDLING

Comply with Division 1 - General Provisions and Covenants.

1.06 SCHEDULING AND CONFLICTS

Comply with Division 1 - General Provisions and Covenants.

1.07 SPECIAL REQUIREMENTS

Comply with the current edition of the MUTCD as adopted by the Iowa DOT.

1.08 MEASUREMENT AND PAYMENT**A. Traffic Signal:**

1. **Measurement:** Lump sum item; no measurement will be made.
2. **Payment:** Payment will be at the lump sum price for traffic signal installation.

B. Temporary Traffic Signal:

1. **Measurement:** Lump sum item; no measurement will be made.
2. **Payment:** Payment will be at the lump sum price for temporary traffic signal installation.

PART 2 - PRODUCTS**2.01 UNDERGROUND****A. Handhole:****1. General:**

- a. **Cable Hooks:** Provide four galvanized steel cable hooks with a minimum diameter of 3/8 inch and a minimum length of 5 inches.
- b. **Granular Base:** Comply with the following gradations; however, the Engineer may authorize a change in gradation, subject to materials available locally at the time of construction.

Sieve	Percent Passing
2"	100
1 1/2"	80 to 90
1"	15 to 20
3/4"	0 to 0.5

- c. **Cover:** Include "TRAFFIC SIGNAL" as a message on the cover. Alternate messages may be required as specified in the contract documents.

2. Precast Concrete Handhole:

- a. **Pipe:** Comply with ASTM C 76. Minimum Class III, Wall B (Iowa DOT Class 2000D). Four, 8 inch knockouts (conduit entrance points) equally spaced around the handhole.
- b. **Casting:** Gray cast iron and certified according to requirements of AASHTO M 306 for a 16,000 pound proof-load (HS-20).

3. Composite Handhole and Cover: Composed of mortar consisting of sand, gravel, and polyester resin reinforced by a woven glass fiber mat or of resin mortar and fiberglass. Ensure the handhole and cover withstands a load of 20,000 pounds. Provide a skid resistant surface on the cover. Provide two 3/8-16 UNC stainless steel hex head bolts with washers.**B. Conduit:****1. General:**

- a. Furnish weatherproof fittings of identical or compatible material to the conduit. Use standard factory elbows, couplings, and other fittings.
- b. Use a manufactured conduit sealing compound that is readily workable material at temperatures as low as 30°F and will not melt or run at temperatures as high as 300°F.

2. Steel Conduit and Fittings:

- a. Comply with ANSI C80.1.
- b. Use weatherproof expansion fittings with galvanized, malleable iron, fixed and expansion heads jointed by rigid steel conduit sleeves. As an option, the fixed head may be integral with the sleeve, forming a one piece body of galvanized malleable iron.
- c. Provide steel bushings.

3. Plastic Conduit and Fittings:

- a. **PVC:**
 - 1) PVC Schedule 40 plastic conduit and fittings complying with NEMA TC-2 (pipe), NEMA TC-3 (fittings), and UL 651 for Schedule 40 heavy wall type.

2.01 UNDERGROUND (Continued)

- 2) Solvent welded, socket type fittings, except where otherwise specified in the contract documents.
 - 3) Threaded adaptors for jointing plastic conduit to rigid metal ducts.
 - 4) Provide bell end fittings or bushings.
- b. HDPE:**
- 1) Comply with ASTM F 2160 (conduit) and ASTM D 3350 (HDPE material), SDR 13.5.
 - 2) Use orange colored conduit.
 - 3) Continuous reel or straight pieces to minimize splicing.
 - 4) For dissimilar conduit connections, provide an adhesive compatible with both materials.
- C. Wiring and Cable:** Provide wire that is plainly marked on the outside of the sheath with the manufacturer's name and identification of the type of the cable.
1. **Power Cable:** Comply with Iowa DOT Article 4185.12.
 2. **Signal Cable:** Comply with IMSA Specifications 19-1 (PVC jacket) or 20-1 (polyethylene jacket) for polyethylene insulated, 600 volt, solid, multi-conductor copper wire, #14 American Wire Gauge (AWG).
 3. **Tracer Wire:** Comply with #10 AWG, single conductor, stranded copper, Type thermoplastic high-heat nylon-coated (THHN), with UL approval, and an orange colored jacket.
 4. **Communications Cable:** Comply with IMSA Specifications 39-2 or 40-2 for #19 AWG, solid copper conductor, twisted pairs. Use polyethylene insulated, aluminum shielded, complying with REA Specification PE-39 for paired communication cable with electrical shielding.
 5. **Category 5E (Cat5E) Cable:** Provide outdoor use rated cable.
 6. **Fiber Optic Cable and Accessories:**
 - a. Furnish fiber optic cable of the mode type, size, and number of fibers specified in the contract documents, and all associated accessories.
 - b. Meet the latest applicable standard specifications by ANSI, Electronics Industries Association (EIA), and Telecommunications Industries Association (TIA).
 - c. Multimode Fiber:
 - Core Diameter: $62.5 \mu\text{m} \pm 1.0 \mu\text{m}$
 - Cladding Diameter: $125.0 \mu\text{m} \pm 1.0 \mu\text{m}$
 - Core Concentricity: $\pm 1\%$
 - Max. Attenuation: 3.50 dB/km @ 850 nm
 - d. Single-Mode Fiber:
 - Typical Core Diameter: $8.3 \mu\text{m} \pm 1.0 \mu\text{m}$
 - Cladding Diameter: $125.0 \mu\text{m} \pm 1.0 \mu\text{m}$
 - Core Concentricity: $\pm 1\%$
 - Attenuation Uniformity: No point discontinuity greater than 0.1 dB at either 1310 nm or 1550 nm
 - Max. Attenuation: 0.25 dB/km @ 1550 nm, 0.35 dB/km @ 1310 nm
 - e. Dual layer UV cured acrylate coating applied by the fiber manufacturer, mechanically or chemically strip-able without damage to the fiber.
 - f. Glass reinforced plastic rod central member designed to prevent the buckling of the cable. Cable core interstices filled with water blocking tape to prevent water infiltration. Dielectric fillers may be included in the cable core where needed to lend symmetry to the cable cross-section.

2.01 UNDERGROUND (Continued)

- g. Buffer tubes of dual layer construction with a polycarbonate inner layer and polyester outer layer. Each buffer tube filled with a water-swellable yarn or tape. Buffer tubes stranded around the central member using reverse oscillation or "SZ" stranding process. Gel-free cable and buffer tubes.
- h. Buffer tubes and fibers meeting TIA/EIA-598A, "Color coding of fiber optic cables," with 12 fibers per buffer tube.
- i. Cable tensile strength provided by a high tensile strength aramid yarn and/or fiber glass.
- j. All dielectric cables, without armoring, sheathed with medium density polyethylene (1.4 mm minimum nominal jacket thickness). Jacketing material applied directly over the tensile strength members and flooding compound. Jacket or sheath marked in a contrasting color with the manufacturer's name and the words "Optical Cable," the year of manufacture, and sequential meter or feet marks. Additionally, provide a durable weather proof label on the cable jacket showing the actual attenuation of each fiber expressed in dB/km.
- k. Cable fabricated to withstand a maximum pulling tension of 600 pounds during installation (short term) and 135 pounds upon installation (long term).
- l. Shipping, storing, and operating temperature range of the cable: -40° C to + 70° C. Installation temperature range of cable: -10° C to + 60° C.
- m. Each fiber of all fiber optic cable tested by manufacturer at the 100% level for the following tests:
 - Proof tested at a minimum load of 50 kpsi (350 Mpa)
 - Attenuation
- n. Meet the appropriate standard Fiber Optic Test Procedure for the following measurements:
 - Fluid Penetration
 - Compound Drip
 - Compressive Loading Resistance
 - Cyclic Flexing
 - Cyclic Impact
 - Tensile Loading and Bending
- o. Make cable ends available for testing. Seal cable ends to prevent moisture impregnation.
- p. Fiber Distribution Panel: Provide a fiber distribution panel capable of terminating a minimum of 24 fibers, or as specified in the contract documents.
- q. Fiber Optic Connectors:
 - 1) ST type connectors of ceramic ferrule and physical contact end finish to terminate multi-mode fibers to equipment.
 - 2) SC type connectors of ceramic ferrule and physical contact end finish to terminate single-mode fibers to equipment.
 - 3) ST or mechanical connectors not allowed for cable splices.
 - 4) Maximum attenuation per connector: 0.75 dB.
- r. Fiber Optic Jumpers/Patch Cords: For connections in the cabinet, provide factory-assembled duplex pigtail jumpers with dielectric strength member, durable outer jacket and ST or SC compatible connectors. Provide adequate length for connections and 2 feet minimum slack.
- s. Fiber Optic Breakout Kits: Provide breakout kits for separation and protection of individual fibers, with buffering tube and jacketing materials suitable for termination of the fiber and fiber optic connector.
- t. Splices/ Splice Enclosures: Fusion splice continuous fiber runs or branch circuit connections in splice enclosures as allowed or specified in the contract documents. Provide environmentally protected outside plant splice enclosures with adequate number of trays to splice all fibers. Maximum attenuation per splice: 0.3 dB.

2.01 UNDERGROUND (Continued)**D. Footings:**

1. Use Class C structural concrete complying with Iowa DOT Section 2403.
2. Use uncoated reinforcing steel complying with Iowa DOT Section 4151.

E. Bonding and Grounding:

1. **Ground Rods:** Provide 5/8 inch by 8 foot copper clad, steel ground rod at each pole and controller footing.
2. **Bonding Jumper or Connecting Wire:** Provide #6 AWG bare conductor, copper wire.

2.02 DETECTION

A. Inductive Loop Vehicle Detector: A detector consists of a conductor loop or series of loops installed in the roadway, lead-in (feeder) cable, and a sensor (amplifier) unit with power supply installed in a traffic signal controller cabinet.

1. **Cables:** All cables must be UL approved.
 - a. **Tube Loop Detector Cable:** Comply with IMSA Specifications 51-5.
 - b. **Preformed Loop Detector Cable:** As approved by the Engineer.
 - c. **Loop Detector Lead-in Cable:** Comply with IMSA Specifications 50-2.
2. **Detector Loop Sealant:**
 - a. Use a rapid cure, high viscosity, liquid epoxy sealant formulated for use in sealing inductive wire loops and leads embedded in pavement. Ensure the cured sealer is unaffected by oils, gasoline, grease, acids, and most alkalis.
 - b. Use a sealant complying with Iowa DOT Materials I.M. 491.18.
3. **Sensor (Amplifier) Unit:**
 - a. Use a sensor unit that is solid state, digital, providing detection channel(s) with an inductance range of 0 to 2,000 micro-henries. Output circuits of the sensor unit will be provided by relays. Vehicle presence will result in a continuous call indication.
 - b. Provide a sensor unit with the following qualities:
 - 1) Sensitivity adjustment to allow as a minimum the selection of high, medium, or low sensitivity.
 - 2) Be capable of providing reliable detection of all licensed motor vehicles.
 - 3) Provide an indicator light for visual indication of each vehicle detection.
 - 4) Will not require external equipment for tuning or adjustment.
 - 5) Provide operation in the pulse mode or presence mode. Ensure mode switch is readily accessible.
 - 6) Provide a self tuning system that is activated automatically with each application of power. Provide automatic and continuous fine tuning to correct for environmental drift of loop impedance.
 - 7) Provide for fail-safe operation (continuous call) in the event of detector loop failure.
 - 8) Ensure each detector channel will respond to a frequency shift in an increasing or decreasing value as occurs with temperature shifts in the pavement without requiring a locked call.
 - 9) Use detector units with delay and extension timing. The delay feature is selected and adjusted externally on the sensor unit housing. Digitally derived timing is selectable in 1 second increments from 0 to 30 seconds. Ensure delay timing inhibits detector output until presence has been maintained for the time selected. Restart delay timer at each new detection.

2.02 DETECTION (Continued)

- 10) Use a sensor unit capable of normal operation without interference and false calls between sensor units ("crosstalk") when installed in the physical environment of the controller cabinet and the electrical environment of the associated electronic equipment installed therein, including other detectors.

B. Pedestrian Push Button Detectors:**1. Assembly:**

- a. Ensure the entire assembly is weather tight, secure against electrical shock, withstands continuous hard usage.
- b. Provide a removable contact assembly mounted in a die cast aluminum case.
- c. Ensure contacts are normally open with no current flowing except at the moment of actuation.
- d. Ensure the contacts are entirely insulated from the housing and operating button with terminals for making connections.
- e. Provide housing with one outlet for 1/2 inch pipe.

2. Operating Button:

- a. Nonrusting metal alloy.
- b. Ensure the button does not protrude out from the case.
- c. Supply ADA compliant operating button.

3. Signs: Furnish signs complying with MUTCD.**C. Video Detection Camera System:** Detects vehicles by processing video images and providing detection outputs to the traffic signal controller.**1. Video Detection System and Processors:**

- a. Processor to be card rack mounted or located within camera. Compatible with NEMA TS-1, TS-2, and Type 170 controllers and cabinets.
- b. Must be capable of the following:
 - 1) Shadow rejection without special hardware.
 - 2) Non-impaired operation under light intensity changes.
 - 3) Maintained operation during various weather conditions (e.g. rain, fog, snow).
 - 4) Anti-vibration, 5% rejection based on image change.
 - 5) Ability to select direction of flow parameters.
 - 6) Ability to properly detect directionally.
 - 7) Operate in presence mode with less than 4% error.
- c. Provide user-defined detection zone programming via a graphical user interface (GUI) and any necessary equipment for future programming. Store detection zones in non-volatile memory.
- d. Comply with NEMA TS-1 and TS-2 environmental and physical standards with an operating temperature of -34°C to +60°C, and 0% to 95% relative humidity.
- e. Ensure a factory certified representative from the supplier provides on-site VDS programming and testing.

2. Video Cameras:

- a. Provide a charge-coupled device (CCD) image sensor with variable focus color or black and white lens providing a minimum of 4 to at least a 40 degree horizontal field of view.
- b. Equipped with internal thermostatically controlled heater and external sunshield.
- c. Meet NEMA-4 or NEMA-6P environmental standards.
- d. Use camera cable(s) meeting the manufacturer's recommendations. Provide a continuous run, without splices, from the camera to the controller cabinet.

2.02 DETECTION (Continued)

D. Microwave Vehicle Detectors: Detects all vehicles moving within the field of detection at speeds from 2 to 80 mph.

1. Must be capable of the following:
 - a. Minimum detection range from 3 to 200 feet for all vehicles.
 - b. Pattern spread of the detection field no more than 16 degrees.
 - c. Self-tuning and capable of continuous operation over a temperature range of -35°F to 165°F.
 - d. Side-fire mount or overhead mount.
 - e. Detecting directional traffic and the direction user selectable.
2. Microprocessor based using Doppler microwave at an operating frequency of 10.525 GHz.
3. FCC certification and tested to the applicable FCC specifications.
4. Enclosure constructed of aluminum or stainless steel and water resistant.
5. All user operated controls and adjustments must be clearly marked and easily accessible.
6. Relay detection output to the controller with a minimum 5 amp rating and designed to place a constant call to the controller in the event of any failure.
7. Easily accessible indicator showing activation of detection relay.
8. Required wiring as recommended by the manufacturer.
9. Provide mounting hardware for the type of mounting specified in the contract documents and power supply equipment as recommended by the manufacturer.

2.03 COMMUNICATIONS

A. Traffic Monitoring System: Provide as specified in the contract documents including, video camera in dome, dome mounting bracket and hardware, camera controller, cabling from camera to controller cabinet, and all accessories and hardware necessary for a complete and operational system.

1. Pan/tilt/zoom (PTZ) color camera with automatic conversion to monochrome during low light levels, auto focus, auto-iris control, electronic image stabilization, privacy masking and high resolution 1/4 inch CCD imager. Minimum optical zoom: 25X. Minimum digital zoom: 12X.
2. Camera system provided in a NEMA 4X or IP66 certified rugged weather-resistant package.
3. Provide all required lightning protection for electronics control, power, and coax video outputs.
4. Operating temperature range: -40°C to +50°C.
5. Maximum cable length as specified by camera manufacturer.
6. Provide full 360 degree endless pan and 220 degree tilt under PTZ control.

2.03 COMMUNICATIONS (Continued)

7. Dome electronics capable of programming a minimum of 64 preset views and nine preprogrammed pattern sequences of preset views. All views selectable by the central office computer or a remote control device.
8. Provide encoder and decoder devices as needed to transmit video over existing or proposed communication systems at 30 frames per second.
9. Provide all necessary rack support devices for video viewing and PTZ control.
10. Provide ability to control PTZ and view video remotely.

B. Fiber Optic Hub Cabinet: As specified in the contract documents.

C. Wireless Interconnect Network: Provides two-way data communication between the on-street master controller and local traffic signal controllers.

1. Data Transceiver:

- a. Utilize a license-free spread spectrum radio frequency (902-928 MHz) with frequency hopping technology.
- b. Completely programmable by software. Furnish software to the Jurisdiction.
- c. Built-in diagnostics capabilities.
- d. Configurable as master, slave, or repeater with store and forward capability.
- e. Maintains user selectable power output levels between 0.1 and 1 watt.
- f. Operates with input voltages between 6 VDC and 30 VDC.
- g. RS-232 interface with 115.2 kbps capability.
- h. Operating temperature of -40°C to +75°C.
- i. Receiver sensitivity of -108 to -110 dBm at 10^{-6} BER.
- j. Protected from power surges.
- k. Rack or shelf mounted in controller cabinet and connections for antenna, power, and controller.

2. Antenna:

- a. Capable of transmitting and receiving data between intersections.
- b. Mount near the top of the signal pole nearest the controller cabinet or as specified in the contract documents. Provide engineer-approved mounting hardware.
- c. Connect to transceiver via appropriate cable from pole to signal cabinet in same conduit as traffic signal cable. Conceal cable within a watertight connection at antenna.

2.04 CABINET AND CONTROLLER

A. NEMA Controller, Cabinet, and Auxiliary Equipment: Comply with the latest edition of NEMA TS1 or TS2 standards.

1. Controller:

- a. Solid state modular design with digital timing and capable of accommodating at least eight phases.
- b. Fully prompted, front panel keyboard with menu driven programmability.
- c. Local time base scheduler including automatic accommodation for daylight savings time.
- d. Local coordination control.
- e. Local preemption control with at least four programmable internal preemption sequences.
- f. Current software and documentation.
- g. Data retained in a memory medium that does not require battery backup.

2.04 CABINET AND CONTROLLER (Continued)**2. Cabinet:**

- a. Unpainted aluminum cabinet according to NEMA standards.
- b. Aluminum cabinet riser with same dimensions as cabinet and 12 to 18 inch height, as specified in the contract documents.
- c. Police door with auto/flash switch and on/off power switch for signal heads only. Controller to remain in full operation regardless of switch positions.
- d. Maintenance panel on inside of the main door containing the following test switches.
 - 1) Controller power switch.
 - 2) Detector test switches.
 - 3) Stop time switch.
 - 4) Signal flash switch.
- e. Heavy-duty clear plastic envelope attached to inside wall of cabinet or cabinet door, for cabinet wiring diagrams, 12 inches by 18 inches minimum.
- f. GFI electrical outlet and lamp in accessible location near the front of the cabinet. GFI outlet fused separately from main AC circuit breaker. Fluorescent or LED cabinet lamp connected and fused with GFI outlet.
- g. Back panel positions to accommodate phasing and expansibility specified in the contract documents.
- h. Power protection devices including AC power circuit breakers, radio interference suppressors, and lightning and surge protectors.
 - 1) AC field service single pole, nonadjustable, magnetic breaker rated for 117 VAC operation, NEC approved.
 - 2) Radio interference suppressors (RIS) as required to minimize interference in all broadcast transmission and aircraft frequency bands.
 - 3) Lightning arrestor/surge protector capable of withstanding repeated (minimum of 25) 30,000 ampere surges.
- i. Neatly train wiring throughout the cabinet and riser. Bundle and attach wiring to interior panels using nonconductive clamps or tie-wraps.

- 3. Auxiliary Equipment:** Conflict monitor/malfunction management unit, flasher, load switches, terminals and facilities, and miscellaneous equipment and materials according to NEMA standards.

- B. Uninterruptible Power Supply Battery Backup System:** Monitors 120VAC input from the electric utility source and automatically switches to/from a system consisting of batteries and electronics.

1. Include a maintenance bypass switch to allow operation of the traffic signal system while repairs are made to the battery backup system.
2. Designed to provide a minimum of 4 hours of normal operation.
3. Use cabinet equipment that is plug connected and shelf mounted.
4. Designed to cover a temperature range from -30°F to +165°F and include a surge suppressor.

- C. Emergency Vehicle Preemption System:** As specified in the contract documents.

2.05 POLES, HEADS, AND SIGNS**A. Vehicle Traffic Signal Head Assembly:** Comply with current MUTCD and ITE standards.**1. Housing:**

- a. Individual signal sections made of a durable polycarbonate. Use color specified in the contract documents. Color to be an integral part of the materials composition.
- b. Self-contained unit capable of separate mounting or inclusion in a signal face containing two or more signal sections rigidly and securely fastened together.
- c. Equipped with openings and positive locking devices in the top and bottom so that it may be rotated between waterproof supporting brackets capable of being directed and secured at any angle in the horizontal plane.
- d. Doors and lenses with suitable watertight gaskets and doors that are suitably hinged and held securely to the body of the housing by simple locking devices of non-corrosive material. Doors are to be easily removed and reinstalled without use of special tools.

2. Optical System: Designed to prevent any objectionable reflection of sun rays even at times of the day when the sun may shine directly into the lens.**3. Lenses:** 12 inch diameter polycarbonate. Do not use glass lenses.**4. Visors:****a. Standard Installation:**

- 1) Each signal lens is to have a visor with the bottom 25% open.
- 2) Minimum 0.1 inch in thickness and black in color.
- 3) Fits tightly against the housing door with no filtration of light between the visor and door.
- 4) Minimum length of 9 1/2 inches. Ensure the visor angle is slightly downward.

b. Optically Programmed Sections: Make sure the optical unit and visor are designed as a whole to eliminate the return of outside rays entering the unit from above the horizontal.**5. Terminal Block:**

- a. Three-section signal equipped with a six position terminal block.
- b. Four- and five-section signal equipped with an eight position terminal block.

6. Backplate:

- a. Manufactured one-piece, durable, black plastic capable of withstanding a 100 mph wind.
- b. Provides 5 inches of black field around the assembly.

7. Mounting Hardware:

- a. **Fixed:** 1 1/2 inch aluminum pipe and fittings, natural aluminum finish for galvanized poles or match the pole color. Secure to pole with a minimum 5/8 inch wide stainless steel banding material.
- b. **Universally Adjustable:** Rigid mounted, consisting of both top and bottom brackets and easily adjustable in both horizontal and vertical planes.

8. LED Modules: Comply with current ITE standards.

2.05 POLES, HEADS, AND SIGNS (Continued)**B. Pedestrian Traffic Signal Head Assembly:** Comply with current MUTCD and ITE standards.**1. Housing:**

- a. Made of a durable polycarbonate. Use color specified in the contract documents. Color to be an integral part of the materials composition.
- b. Self-contained unit capable of separate mounting or inclusion in a signal face containing one or more signal sections rigidly and securely fastened together.
- c. Equipped with openings and positive locking devices in the top and bottom so that it may be rotated between waterproof supporting brackets capable of being directed and secured at any angle in the horizontal plane.
- d. Doors and lenses with suitable watertight gaskets and doors that are suitably hinged and held securely to the body of the housing by simple locking devices of non-corrosive material. Doors are to be easily removed and reinstalled without use of special tools.

2. Visor:

- a. Tunnel type visor attached to the housing door by stainless steel screws.
- b. Fit tightly against the housing door to prevent any filtration of light between the door and the visor.
- c. Ensure the visor angle is slightly downward.

3. LED Module:

- a. Provide a LED unit(s) for the filled upraised hand symbol, walking person symbol, and countdown timer.
- b. Ensure immediate blank out of the countdown timer display upon recognizing a shortened "Walk" or a shortened "Flashing Don't Walk" interval.

C. Traffic Signal Poles and Mast Arms:**1. General:**

- a. Mast arm length and vertical pole height as specified in the contract documents.
- b. Ensure the mast arms, poles, and supporting bases are galvanized inside and out according to ASTM A 123.
- c. Continuous tapered, round, steel poles of the transformer base type. Fabricated from low carbon (maximum carbon 0.30%) steel of U.S. standard gauge.
- d. When a transformer base is not specified, provide a 6 inch by 16 inch handhole in the pole shaft for cable access. Provide a cover for the handhole. Secure the cover to the base with simple tools. Hardware to be corrosion resistant.
- e. Ensure minimum yield strength of 48,000 psi after manufacture. Supply base and flange plates of structural steel complying with AASHTO M 183 (ASTM A 36) and cast steel complying with ASTM A 27, Grade 65-35 or better.
- f. Where a combination street lighting/signal pole is specified in the contract documents, the luminaire arm is to be mounted in the same vertical plane as the signal arm unless otherwise specified. Use a single member tapered type arm for the luminaire arm type. Equip the pole with a minimum 4 inch by 6 inch handhole and cover located opposite the signal mast arm.
- g. If allowed by the Engineer, poles and mast arms may be fabricated by welding two sections together, resulting in a smooth joint and factory welded as follows:
 - 1) Ensure a minimum of 60% penetration for plates 3/8 inch and less in thickness for longitudinal butt welds, except within one foot of a transverse butt-welded joint. Ensure a minimum of 80% penetration for plates over 3/8 inch in thickness.
 - 2) Ensure 100% penetration for longitudinal butt welds on poles and arms within one foot of a transverse butt-welded joint.
 - 3) Ensure 100% penetration, achieved by back-up ring or bar, for transverse butt welds for connecting.

2.05 POLES, HEADS, AND SIGNS (Continued)

- 4) Examine 100% of transverse butt welds and 100% penetration longitudinal butt welds by ultrasonic inspection according to the requirements of AWS D1.1-80.AH.
- 5) Comply with Structural Welding Code AWS D1-180, as modified by AASHTO 1981 Standard Specifications for Welding of Structural Steel Highway Bridges and by Supplemental Specifications No. 969.
- h. Provide non-shrink grout (complying with Iowa DOT Materials I.M. 491.13) or a rodent guard (complying with Iowa DOT Materials I.M. 443.01) for placement between the pole base and the foundation.

2. Pole Design:

- a. Comply with AASHTO *Standard Specifications for Structural Supports for Highway Signs, Luminaires, and Traffic Signals*, 1994.
- b. Designed to support the loading necessary for all traffic control equipment. Capable of withstanding winds up to 80 MPH with a 1.3 gust factor without failure.

3. Hardware:

- a. Equipped with all necessary hardware and anchor bolts to provide for a complete installation without additional parts.
- b. Anchor bolts complying with ASTM F 1554 Grade 105, hot dip galvanized and threaded a minimum of 6 inches at one end and have a 4 inch long, 90 degree bend at the other end.
- c. Washers complying with ASTM F 436.
- d. Heavy hex nuts complying with ASTM A 563.
- e. All hardware made of steel, hot dipped galvanized complying with ASTM F 2329, or ASTM B 695, Class 50, Type I, or electrodeposited coated of the same coating thickness and designed for this purpose.

D. Traffic Signal Pedestal Poles:**1. Materials:**

- a. **Pedestal:** The height from the bottom of the base to the top of the shaft as specified in the contract documents.
- b. **Pedestal Shaft:** Schedule 80 with satin brush or spun finish aluminum tubing. Top of the shaft outer diameter to be 4 1/2 inches and provided with a pole cap. Supply base collar for poles with shaft lengths greater than 10 feet.
- c. **Pedestal Base:** Cast aluminum, square in shape, with a handhole.
 - 1) **Handhole:** Minimum of 6 inches by 6 inches and equipped with a cast aluminum cover that can be securely fastened to the base with the use of simple tools.
 - 2) **Base:** Minimum weight of 20 pounds with a four bolt pattern uniformly spaced on a 12 1/2 inch diameter bolt circle. Meet or exceed AASHTO breakaway requirements.

2. **Anchor Bolts:** Four 3/4 inch by 15 inch steel, hot dip galvanized anchor bolts with right angle bend at the bottom end, complete with all hardware required for installation.

2.05 POLES, HEADS, AND SIGNS (Continued)**E. Pedestrian Push Button Post:****1. Material:**

- a. Post:** Standard weight (Schedule 40) pipe complying with ASTM F 1083, galvanized inside and out; 2 1/2 inches in diameter.
- b. Cap:** Waterproof cap complying with ASTM F 626.
- c. Anchor Bolts:** Four 1/2 inch by 24 inch steel, hot dip galvanized anchor bolts complete with all hardware required for installation.
- d. Non-shrink Grout:** Comply with Iowa DOT Materials I.M. 491.13 or a rodent guard (complying with Iowa DOT Materials I.M. 443.01) for placement between the post base and the foundation.
- e. Base Plate:** Provide a 5 inch square, 1/2 inch thick galvanized steel base plate with a 4 1/2 inch bolt circle.

F. Traffic Signs:

1. Comply with Iowa DOT Section 4186.
2. Use a universally adjustable mast arm mounted sign bracket.
3. Comply with MUTCD and the contract documents for the street name sign dimensions, letter height and font, and sheeting.

PART 3 - EXECUTION**3.01 UNDERGROUND****A. Handhole:****1. Locations:**

- a. Do not construct in ditch bottoms, low areas where ponding of water may occur, or where they will be subject to normal vehicular traffic.
- b. With Engineer approval, additional handholes may be placed, at no additional cost to the Contracting Authority, to facilitate the work.

2. Excavation: Excavate as necessary to accommodate the handhole and granular base.**3. Granular Base:** Install 8 inch thick granular base extending a minimum of 6 inches beyond the outside walls of the handhole.**4. Placement:**

- a. In paved areas, install the handhole at an elevation so the casting is level and flush with the pavement. In unpaved areas, install the handhole approximately 1 inch above the final grade.
- b. Verify ring placement. Invert rings when installed in paved areas.

5. Conduit:

- a. Remove knockouts as necessary to facilitate conduit entrance.
- b. Extend conduit into the handhole, through a knockout, approximately 2 inches beyond the inside wall. Conduit to slope down and away from the handhole.
- c. Place non-shrink grout (complying with Iowa DOT Materials I.M. 491.13) in the opening of the knockout area after placement of conduit.

6. Cable Hooks: Install cable hooks centered between the knockouts and the top of the handhole.**7. Backfill:** Place suitable backfill material according to Section 3010.**8. Casting:** Place the casting on the handhole. Ensure the final elevation meets the handhole placement requirements.**B. Conduit:****1. General:**

- a. Place conduit to a minimum depth of 30 inches and a maximum depth of 60 inches below the gutterline. When conduit is placed behind the curb, place to a minimum depth of 24 inches and a maximum depth of 48 inches below top of curb.
- b. Change direction at handholes or by bending, such that the conduit will not be damaged or its internal diameter changed. Ensure bends are uniform in curvature and the inside radius of curvature of any bend is no less than six times the internal diameter of the conduit.
- c. On the exposed ends of conduit, place bell-end fittings on PVC or HDPE conduit and bushings on steel conduit prior to installing cable. Extend all conduits a minimum of 2 inches and a maximum of 4 inches above the finished surface of any footing or structural base.

3.01 UNDERGROUND (Continued)

- d. When it is necessary to cut and thread steel conduit, do not allow exposed threads. Ensure conduits and fittings are free from burrs and rough places. Clean, swab, and ream conduit runs before cables are installed. Use nipples to eliminate cutting and threading where short lengths of conduit are required. Coat damaged galvanized finish on conduit with zinc rich paint. Use only galvanized steel fittings with steel conduit.
- e. Pack conduit ends with a conduit sealing compound.

2. Trenched Installation:

- a. Place backfill in layers not to exceed 12 inches in depth with each layer thoroughly compacted before the next layer is placed. Ensure backfill material is free of cinders, broken concrete, or other hard or abrasive materials.
- b. Remove all surplus material from the public right-of-way as soon as possible.

3. Trenchless Installation:

- a. When placing conduit under pavements, use the trenchless installation methods described in Section 3020.
- b. If trenchless methods that compact soils in the bore path are used, provide sufficient cover to prevent heaving of overlying paved surfaces.
- c. Do not allow pits for boring to be closer than 2 feet to the back of curb, unless otherwise specified in the contract documents.

C. Wiring and Cable:

1. Where practical, follow color codes so that the red insulated conductor connects to the red indication terminal, yellow to yellow, and green to green. Ensure cables are properly labeled at the controller by durable labels, or other appropriate methods, attached to the cables. Label home runs for cables as follows: northwest corner is red, southeast corner is blue, northeast corner is green, and southwest corner is orange.
2. Install continuous runs of vehicle and pedestrian signal cables from the vehicle or pedestrian signal head to the handhole compartment of the signal pole base. Install continuous runs of vehicle and pedestrian signal cables from the handhole compartment of the signal pole base to the terminal compartment in the controller cabinet. Do not splice signal cables in underground handholes.
3. Install continuous runs for video detection and emergency vehicle preemption cables from the unit to the controller cabinet.
4. Install continuous runs of power lead-in cables from the service point to the meter socket and from the meter socket to the controller cabinet.
5. Install continuous detector cable from each detector loop to the first handhole adjacent to the loop. Ensure cables are properly labeled at the controller by durable labels, or other appropriate methods, attached to the cables. Install continuous homerun cable from the splice made in the first handhole to the terminal compartment in the controller cabinet. Attach the drain wire of the shielded cable to the ground in the controller cabinet.
6. Provide a minimum of 4 feet of additional cable at each handhole and loosely coil the extra cable on the handhole cable hooks. Provide a minimum of 2 feet of additional cable at each signal pole (measured from the handhole compartment in the pole to the end of the cable). Provide a minimum of 10 feet of additional cable at each controller base.
7. Pull cables through conduit using a cable grip designed to provide a firm hold upon the exterior covering of the cable or cables, and minimize dragging on the ground or pavement.

3.01 UNDERGROUND (Continued)

8. Install a tracer wire in all conduits with the exception of conduits between detector loops and handholes. Use a silicon-filled wire nut to splice the tracer wire in each handhole and at the controller to form a continuous run.
9. Fiber Optic Cable and Accessories:
 - a. Use a suitable cable feeder guide between the cable reel and the face of the conduit to protect the cable and guide the cable directly into the conduit off the reel. During the installation, carefully inspect cable jacket for defects. If defects are found, notify the Engineer prior to any additional cable being installed. Take care when pulling the cable to ensure the cable does not become kinked, crushed, twisted, snapped, etc.
 - b. Attach a pulling eye to the cable and use to pull the cable through the conduit. Use a pulling swivel to preclude twisting of the cable. Lubricate cable prior to entering the conduit with a lubricant recommended by the manufacturer. Use dynamometer or break away pulling swing to ensure the pulling tension does not exceed the specified force of 600 pounds or the cable manufacturer's recommendations, whichever is less. Do not allow the cable to twist, stretch, become crushed, or forced around sharp turns that exceed the bend radius or scar or damage the jacket. Manually assist the pulling of the cable at each pull point.
 - c. Do not pull cable through any intermediate junction box, handhole, pull box, pole base, or any other opening in the conduit unless specified in the contract documents. Install cable by pulling from handhole or controller cabinet to the immediate next downstream handhole or cabinet. Carefully store the remaining length of cable to be installed in the next conduit run(s) in a manner that is not hazardous to pedestrian or vehicular traffic, yet ensures that no damage to the cable occurs. Storage methods are subject to Engineer approval.
 - d. At each handhole, visibly mark or tag cable, "CITY (or COUNTY) FIBER OPTIC"
 - e. Secure cables inside controller cabinet so that no load is applied to exposed fiber strands.
 - f. Ensure the radius of the bend for static storage is no less than 10 times the outside diameter of the cable, or as recommended by the manufacturer. Ensure the radius of the bend during installation is no less than 15 times the outside diameter of the cable, or as recommended by the manufacturer.
 - g. Provide cable slack in each handhole, junction box, and cabinet as specified in the contract documents. Where handholes or junction boxes lack sufficient area for cable storage or bend radius requirements, provide equivalent additional slack in adjacent facilities. Coil and bind slack cable at three points around the cable perimeter and support in its static storage position.
 - h. Install fiber optic accessories according to the manufacturer's recommendations and as specified in the contract documents.
10. Fiber Optic Cable Field Testing: Provide for each fiber both on-reel testing prior to installation and final testing after installation using a high-resolution optical time domain reflectometer (OTDR). Conduct measurements for single-mode fibers at 1310 ± 30 nanometer wavelength. Conduct measurements for multimode fibers at 850 ± 30 nanometer wavelength. Record the identification, location, length, and attenuation measurements of each fiber, and furnish test reports to the Engineer. Replace any cable that fails testing, at no additional cost to the Contracting Authority.
 - a. On-reel Testing: Perform testing for attenuation and continuity using OTDR and a pigtail splice. Complete testing in one direction only. Acceptable test results will be within $\pm 3\%$ of factory-supplied attenuation measurements. Except for access to and test preparation of one end of the newly furnished cable, preserve the cable in its originally-shipped condition. Furnish test reports to the Engineer prior to installation.

3.01 UNDERGROUND (Continued)

- b. **Cable Segment Testing:** Perform an end-to-end attenuation test of each terminated fiber of each fiber optic cable. Perform testing using hand-held optical test sets. Include test results in documentation package provided to the Engineer at the conclusion of the project. Acceptable test results will not exceed the cumulative specified losses of the components. For example, at 850 nanometers, a one kilometer multimode fiber link with two splices and a connector on each end will not exceed 5.6 dB:

1.0 km x 3.5 dB/km:	3.5 dB
0.3 dB per splice x 2:	0.6 dB
0.75 dB per connector x 2:	<u>1.5 dB</u>
Maximum allowable loss:	5.6 dB

Repair or replace any cable segment that fails testing. Retest any repaired or replaced cable. Submit complete documentation of test results to the Engineer (hard copy or electronically).

- c. **Final System Testing:** After complete fiber optic system is installed and terminated, but prior to capping unused fibers, perform OTDR readings on all cables to ensure that each section is in compliance with the specifications. Provide copies of OTDR trace signatures for all fibers for all cable sections to the Engineer. Also provide test results for attenuation test for the installed fibers using the insertion loss procedure and the transmitter/receiver power level test and the continuity test.

D. Footings:

1. **Excavation:** Excavate to the size, shape, and depth specified in the contract documents. Ensure the bottom of all foundations rest securely on firm undisturbed soil. Minimize overexcavation to ensure support and stability of the foundation.
2. **Footing:** Provide a means for holding all of the following elements rigidly in place while the concrete is being placed.
 - a. **Forms:**
 - 1) Set the forms level or sloped to meet the adjacent paved areas.
 - 2) When adjacent to paved areas, shape the top 11 inches of the footing to be square and flush with the surrounding paved area. Provide preformed expansion material between the footing and paved areas.
 - 3) When installed in an unpaved area, set the top of the footing 2 inches above the surface of the ground.
 - b. **Reinforcing Steel:** Install reinforcing steel.
 - c. **Conduit:** Install conduit.
 - d. **Anchor Bolts:**
 - 1) Set anchor bolts using a template constructed to accommodate the specified elevation, orientation, and spacing according to the pole and controller manufacturer's requirements.
 - 2) Center the pole anchor bolts within the concrete footing.
 - 3) Protect the anchor bolts until poles are erected.
 - 4) Orient controller footing with the back of the cabinet toward the intersection such that the signal heads can be viewed while facing the controller, unless otherwise directed by the Engineer.
 - e. **Concrete:**
 - 1) Place concrete to form a monolithic foundation. Consolidate concrete by vibration methods.
 - 2) Finish the top of the base level and round the top edges with an edging tool having a radius of 1/2 inch. Provide a rubbed surface finish on the exposed surface of the footing.

3.01 UNDERGROUND (Continued)

- 3) Allow the footings to cure a minimum of 4 days prior to erecting the poles and 7 days prior to installing the mast arms. Times may be shortened if supported by strength test results.

3. Backfill: Place suitable backfill material according to Section 3010.

E. Bonding and Grounding:

1. Ensure the traffic signal installation is grounded as required by the National Electric Safety Code.
2. Install a ground rod at each signal pole and controller footing.
3. Use PVC conduit within the footing to accommodate the connection between the top of the footing and the ground rod.
4. Bond poles to ground rods with copper wire. Connect ground wires to ground rods with approved mechanical connectors.
5. Bond rigid steel conduit ends in handholes with copper wire and approved fittings.

3.02 DETECTION**A. Detector Loop Cable Installation:**

1. Coordinate the location of the detector loop with the Engineer. Obtain the Engineer's approval prior to cutting the pavement.
2. Saw to ensure proper depth and alignment of the slot. Make a 2 inch deep clean, straight, well-defined 3/8 inch wide saw cut without damage to adjacent areas. Overlap the saw cuts where the detector loop changes direction to provide full depth at all corners. Do not use right angle or corners less than 90 degrees.
3. Before installing the detector loop cable, check the saw cuts for the presence of jagged edges or protrusions and remove if present. Clean and dry the saw cuts to remove cutting dust, grit, oil, moisture, or other contaminants. Clean by flushing with a stream of water under pressure. Use oil-free compressed air to dry the saw cuts.
4. Install detector loop cable without damage. Place three turns of the detector loop cable into the saw cut. Seal the ends of the tubing at the time of placement to prevent entrance of moisture.
5. Ensure the detector loop cables are in the bottom of the saw cut. Place detector loop sealant within the saw cut area. Comply with the manufacturer's instructions for mixing and using the detector loop sealant.
6. Install preformed loop detector according to the manufacturer's recommendations.
7. Identify each detector loop cable in the handhole by phase and location. Wind loops that are physically adjacent in an individual lane or adjacent lanes with opposite rotation (i.e. #1 clockwise, #2 counter-clockwise, #3 clockwise, etc.). Rotation reversal can be accomplished by reversing leads at the handhole.
8. Twist, with at least five turns per foot, all lengths of loop wires and tubing that are not embedded in the pavement.

3.02 DETECTION (Continued)

9. Identify all detector loop lead-in cables with appropriate detector numbers.
10. Use a detector loop cable splice kit for the electrical splice between the detector loop cable and the detector loop lead-in cable to the controller.
 - a. Ensure splice kit provides a watertight protective covering for the spliced wire, the shielding on the detector loop lead-in cable, and the end of the tubing containing the detector loop cable.
 - b. Use a manufactured electrical splice kit approved by the Engineer.
11. Test all loops and document by using the following procedures:
 - a. Determine the insulation resistance of the loop wire using a "megger" with 500V applied to either loop wire to earth ground. The resistance is to be greater than 100 megohms.
 - b. Determine the inductance of the loop using a loop inductance meter.

B. Pedestrian Push Button Detectors:

1. Install according to the manufacturer's recommendations.
2. Seal the wire entrance into the pedestrian push button assembly.

C. Video Detection Camera System: Install according to the manufacturer's recommendations and as specified in the contract documents.**3.03 COMMUNICATIONS****A. Traffic Monitoring System:** Install according to the manufacturer's recommendations and as specified in the contract documents, as well as the following:

1. Position camera dome on the pole as directed by the Engineer.
2. Test installed system under the supervision of the Engineer, and certify as fully-functional.

B. Fiber Optic Hub Cabinet: Install according to the manufacturer's recommendations and as specified in the contract documents.**3.04 CABINET AND CONTROLLER****A. Controller, Cabinet, and Auxiliary Equipment:**

1. Install according to the manufacturer's recommendations and as specified in the contract documents.
2. Install on pre-placed caulking material on the concrete base. After the cabinet is installed in place, place caulking material around the base of the cabinet.

B. Controller: Install according to the manufacturer's recommendations and as specified in the contract documents.**C. UPS Battery Backup System:** Install according to the manufacturer's recommendations and as specified in the contract documents.**D. Emergency Vehicle Preemption System:** Install according to the manufacturer's recommendations and as specified in the contract documents.

3.05 POLES, HEADS, AND SIGNS**A. Vehicle and Pedestrian Traffic Signal Heads:**

1. Inspect each signal head assembly while still on the ground for the following:
 - a. Physical defects
 - b. Visor type
 - c. LED wattage
 - d. Lens orientation
 - e. Wiring connections
2. Attach signal head mounting hardware according to the manufacturer's recommendations. Apply anti-seize compound to all mechanical fasteners.
3. Adjust each signal head both vertically and horizontally to approximate a uniform grade of all like signal heads.
4. During the course of construction and until the signals are placed in operation, cover signal faces or turn away from approaching traffic. When ready for operation, plumb and aim the heads.

B. Traffic Signal and Pedestal Poles and Pedestrian Push Button Posts:

1. Erect all poles and posts vertically under normal load.
2. Securely bolt the bases to the cast-in-place concrete foundations.
 - a. Mast Arm Poles: Provide footing type (A through F) as specified in the contract documents. Level by using two nuts on each anchor bolt or according to the manufacturer's recommendations.
 - b. Pedestal Poles: Level by using metal shims and one nut on each anchor bolt or according to the manufacturer's recommendations.
 - c. Pedestrian Push Button Posts: Weld the post to the base plate using a minimum 3/16 inch weld. Level by using two nuts on each bolt.
3. After leveling the poles, use non-shrink grout or a rodent guard between the pole base and the foundation. When non-shrink grout is used, neatly finish exposed edges of grout to present a pleasing appearance, and place a weep hole in the grout.
4. Apply anti-seize compound to all mechanical fasteners on pole access doors.
5. Install pedestrian push button post caps with tamper-proof set screws per manufacturer's direction or by driving the cap a minimum of 1/2 inch onto the post.

C. Traffic Signs: Install signs using universally adjustable sign brackets banded to the pole. Apply anti-seize compound to all mechanical fasteners.

3.06 TEMPORARY TRAFFIC SIGNAL

Construct according to Figure 8010.107 and to the configuration specified in the contract documents.

3.07 SURFACE RESTORATION

- A. Replace or reconstruct features removed as a part of the work, such as sidewalks, driveways, curbs, roadway pavement, unpaved areas, or any other items.
- B. Complete restoration according the applicable sections of the SUDAS Standard Specifications or as directed by the Engineer.

3.08 TESTING

- A. Notify the Engineer 48 hours in advance of the time and date the signal or signal system will be ready for turn on. Do not turn on the signal or signal system without authorization of the Engineer.
- B. Ensure a representative from the manufacturer and/or supplier of signal controller or other authorized person is at the project site when the signal controllers are ready to be turned on to provide technical assistance including, as a minimum, programming of all necessary input data.
- C. All required signal timing data will be provided by the Engineer.
- D. A test period of 30 calendar days will start upon confirmation from the Engineer that the signal or signal system is operating consistent with the project requirements. Any failure or malfunction of the equipment furnished by the Contractor, occurring during the test period will be corrected by the Contractor at no additional cost to the Contracting Authority. Upon confirmation by the Engineer that any failure or malfunction has been corrected, a new test period of 30 calendar days will start, exclusive of minor malfunctions such as lamp burnouts. Repeat this procedure until the signal equipment has operated satisfactorily for 30 consecutive calendar days.
- E. After signal turn on and prior to completion of the 30 calendar day test period, respond, within 24 hours, to perform maintenance or repair of any failure or malfunction reported.

3.09 DOCUMENTATION

- A. Provide file documentation packages with each signal system, consisting of the following:
 - 1. Complete cabinet wiring diagram.
 - 2. Complete physical description of the equipment.
 - 3. Controller printout or equal documentation of initial controller settings installed in the field or in the office.
 - 4. Product manuals for all cabinet equipment.
 - 5. Standard industry warranties on equipment supplied.
 - 6. Documentation of field cable labeling scheme.
 - 7. Diagram of phasing and detector locations.
 - 8. One set of as-built construction plans indicating changes from the original contract documents.
- B. Supply two complete sets of documentation. One set to be placed in the controller cabinet and the other set (less construction plan) to be delivered to the Engineer.

END OF SECTION

- ① Shape top 11 inches with forms.
- ② Bolt spacing and conduit locations as specified by the manufacturer.

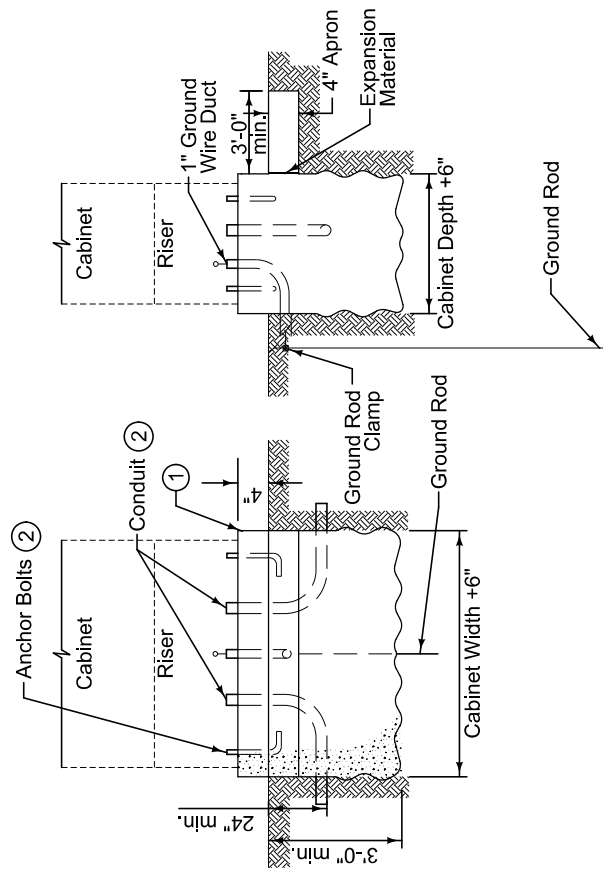

NEMA CONTROLLER CABINET FOOTING

	REVISION	10-16-12
	New	
	8010.101	
SHEET 1 of 1		

SUDAS Standard Specifications

CABINET FOOTING
DETAILS

- ① Shape top 11 inches with forms.
- ② Install rodent guard or non-shrink grout with weep hole.

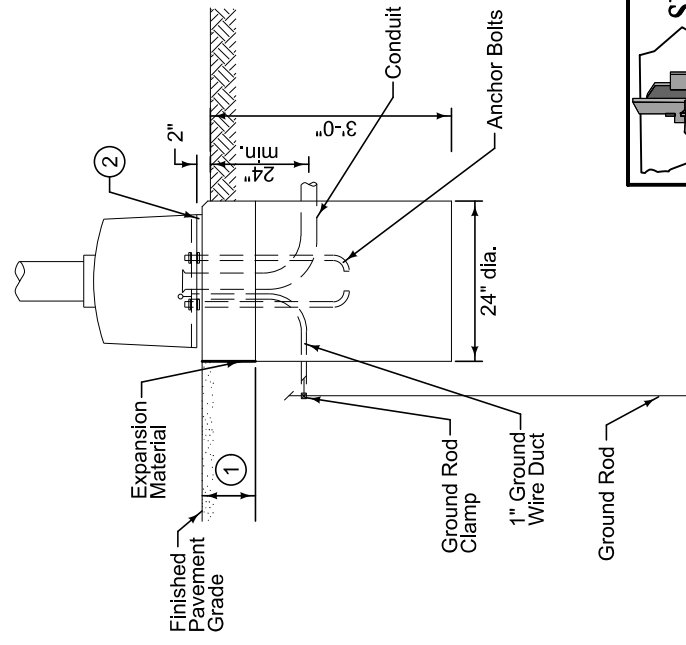

REVISION
New 10-16-12
SUDAS 8010.102
SHEET 1 of 1

SUDAS Standard Specifications
POLE FOOTING DETAILS

PEDESTAL POLE FOOTING

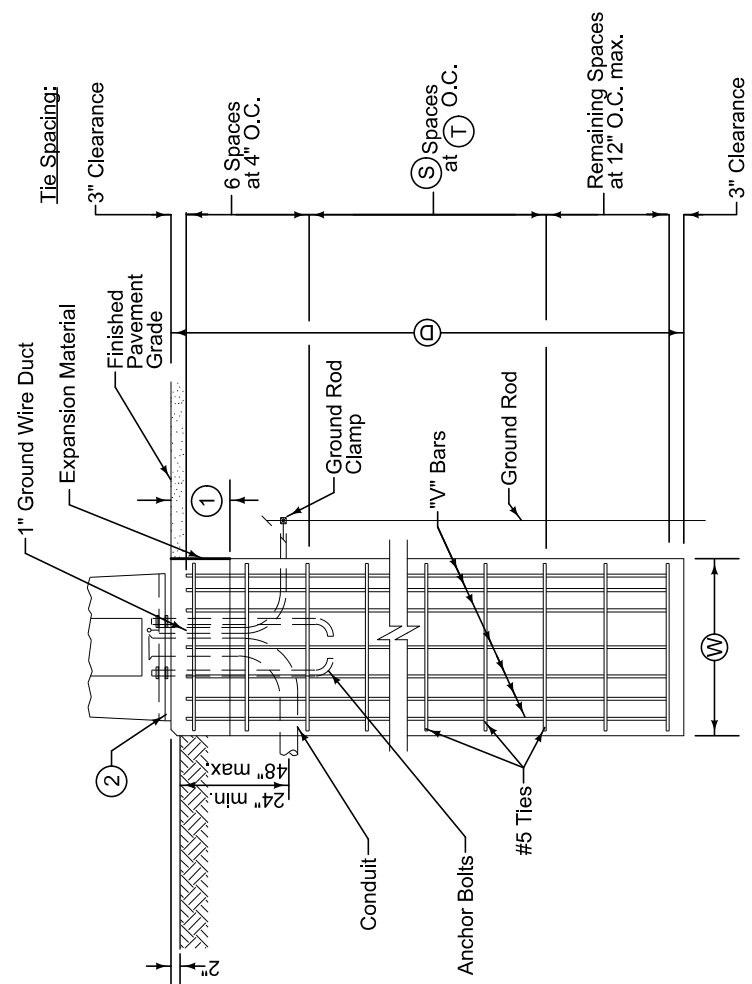

FOOTING DIMENSIONS TABLE

TYPE	(D)	(W)	"V" Bars		(T)
			Count	Size	
A	11'-0"	3'-0"	12	8	8
B	13'-0"	3'-0"	12	8	10
C	15'-0"	3'-0"	12	8	10
D	16'-0"	3'-0"	12	8	10
E	15'-0"	3'-6"	12	10	10
F	16'-0"	3'-6"	12	10	10

Provide footing type as specified in the contract documents.

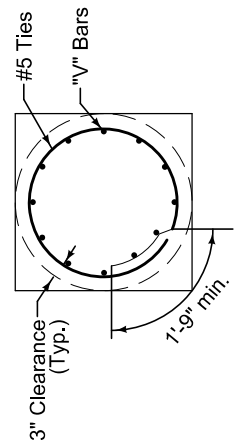

MAST ARM POLE FOOTING

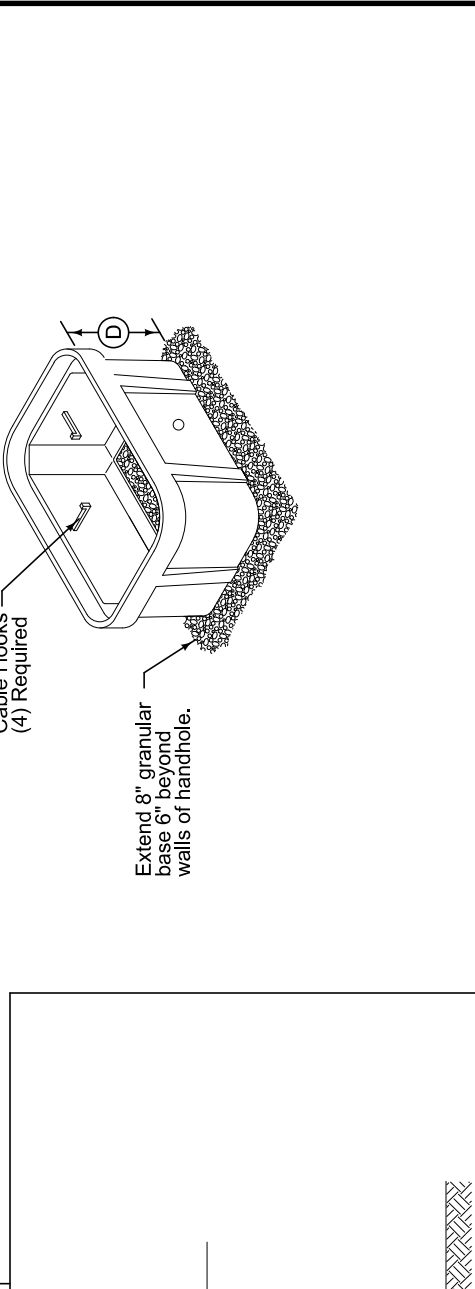
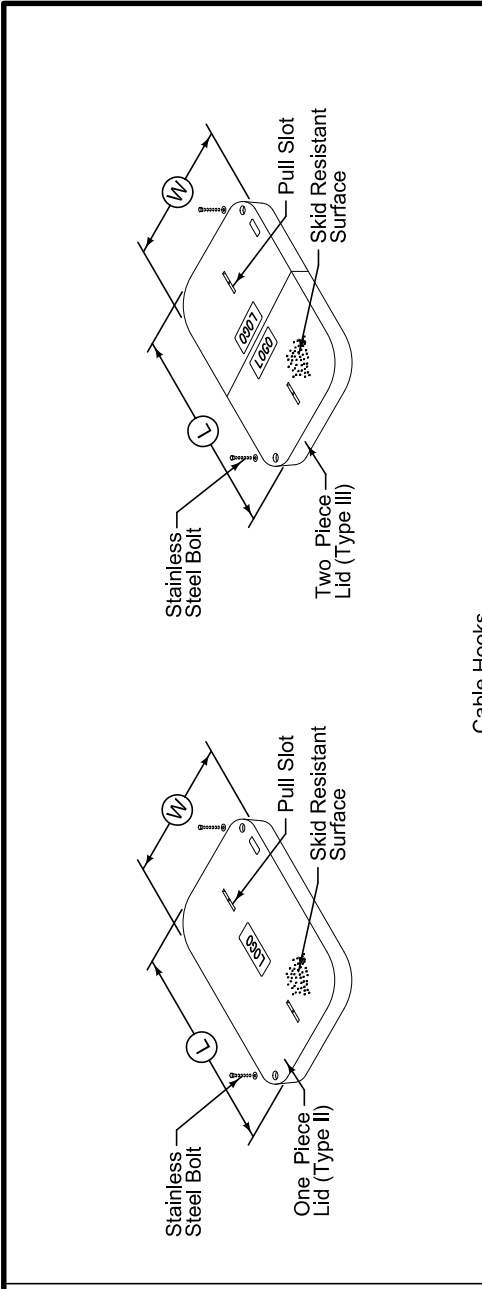
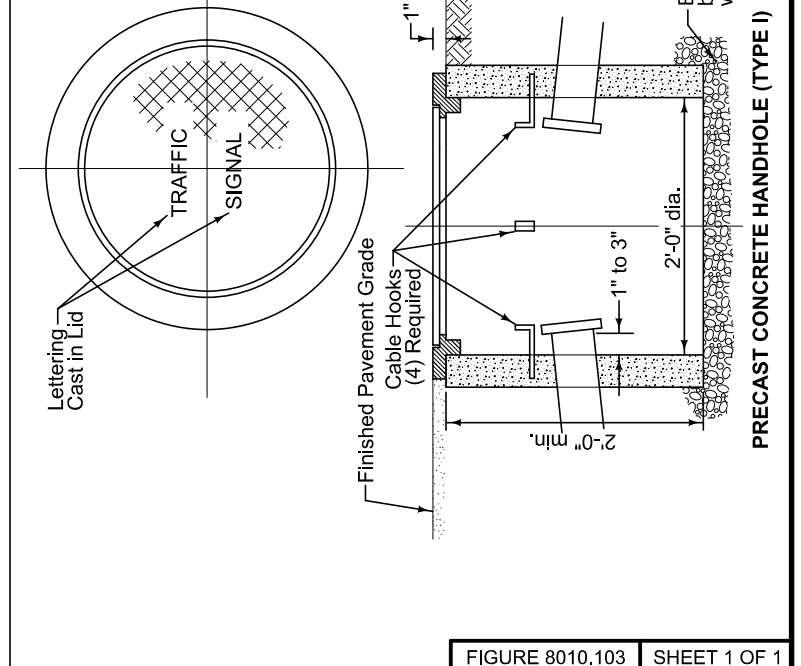
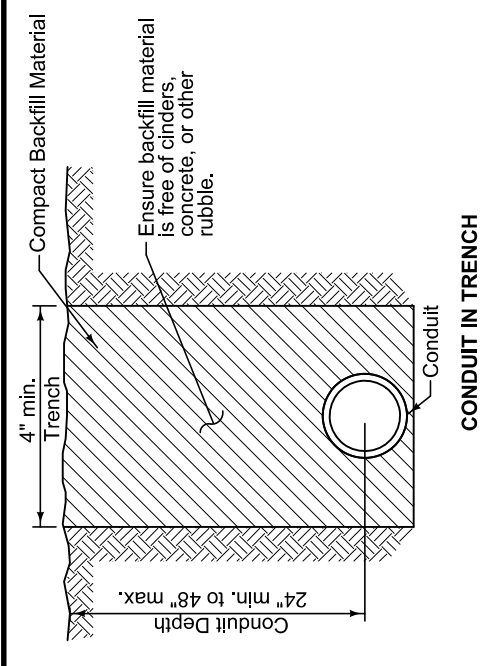

HANDHOLE DIMENSIONS TABLE (NOMINAL)

TYPE	(L)	(W)	(D)
II	36"	24"	30"
III	48"	30"	36"

REVISION
New 10-16-12
SUDAS 8010.103
SHEET 1 of 1

SUDAS Standard Specifications
CONDUIT AND HANDHOLES

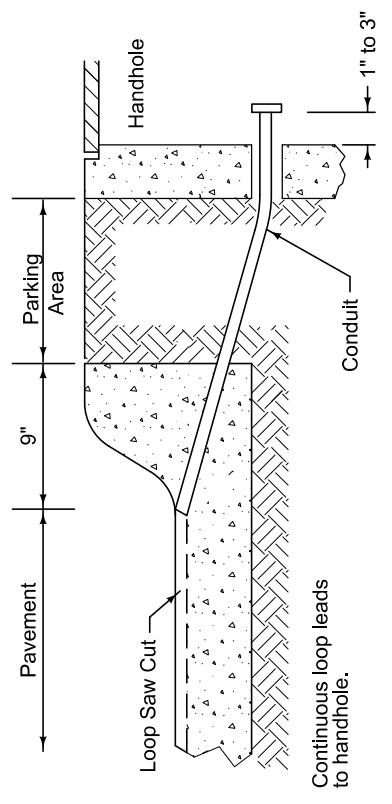
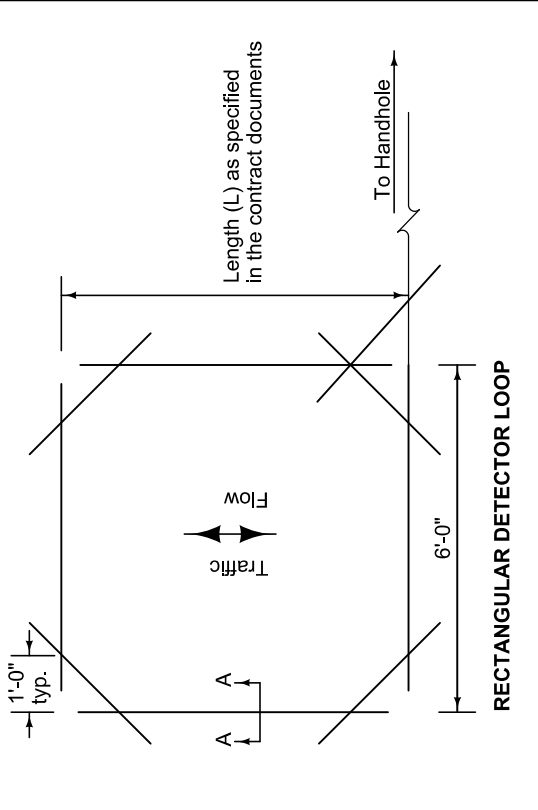
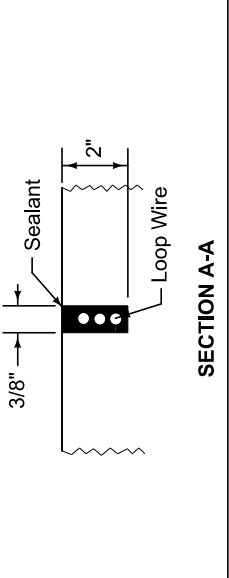
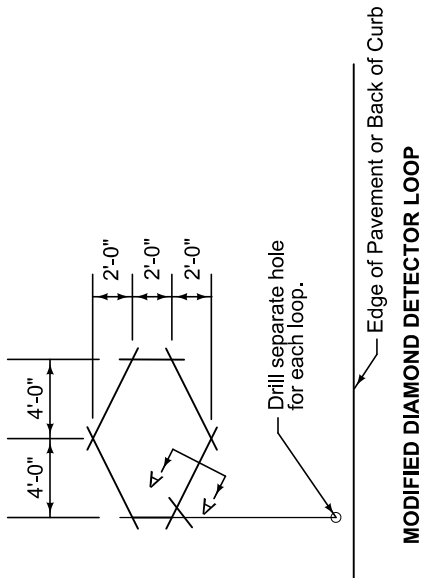

CURB

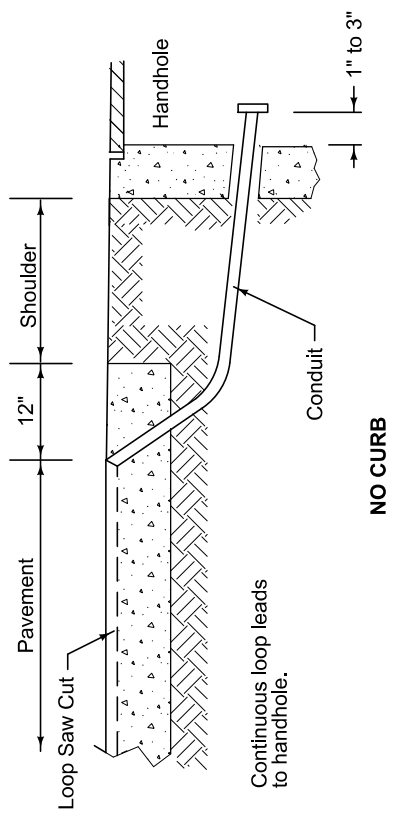

NO CURB

	REVISION	10-16-12
	New	8010.104
		SHEET 1 of 1
SUDAS Standard Specifications		
INDUCTIVE LOOP VEHICLE DETECTORS		

DETECTOR CONDUIT ENTRY

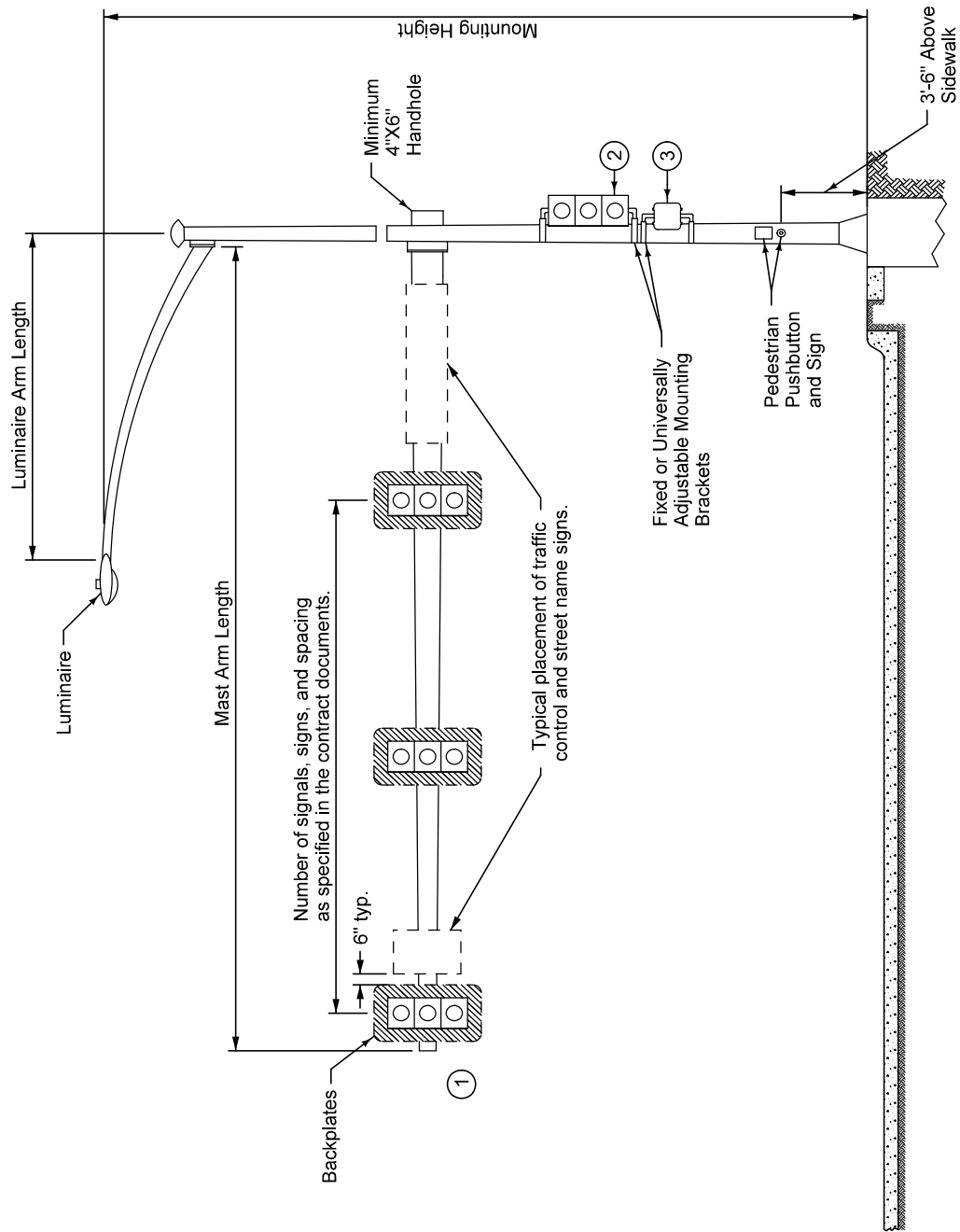

- ① Ensure the top of the signal housing is no more than 25.6 feet above the pavement. Ensure the bottom of the signal housing and related attachments are at least 15 feet above the pavement.
- ② Ensure the bottom of the signal housing (including brackets) that is not located over a roadway is a minimum of 8 feet and a maximum of 19 feet above the sidewalk or, if there is no sidewalk, above the pavement grade at the center of the roadway.
- ③ Mount pedestrian signal heads with the bottom of the signal housing (including brackets) no less than 7 feet or more than 10 feet above the sidewalk level. Position and adjust heads to provide maximum visibility at the beginning of the controlled crosswalk.

	REVISION	New	10-16-12
	8010.105		
SHEET 1 of 1			

SUDAS Standard Specifications

MAST ARM
POLE DETAILS

STEEL MAST ARM POLE

- ① Shape top 11 inches with forms.
- ② Install rodent guard or non-shrink grout with weep hole.
- ③ Provide 1/2 inch diameter hex nut with 1 1/2 inch flat washer. Protect anchor bolt with nut cover.
- ④ Deform threads to prevent nut from backing off.

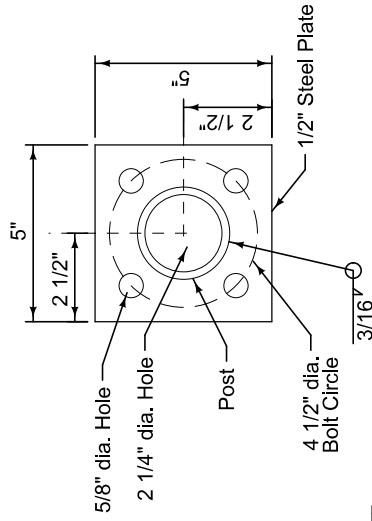

**BASE PLATE
DETAIL**

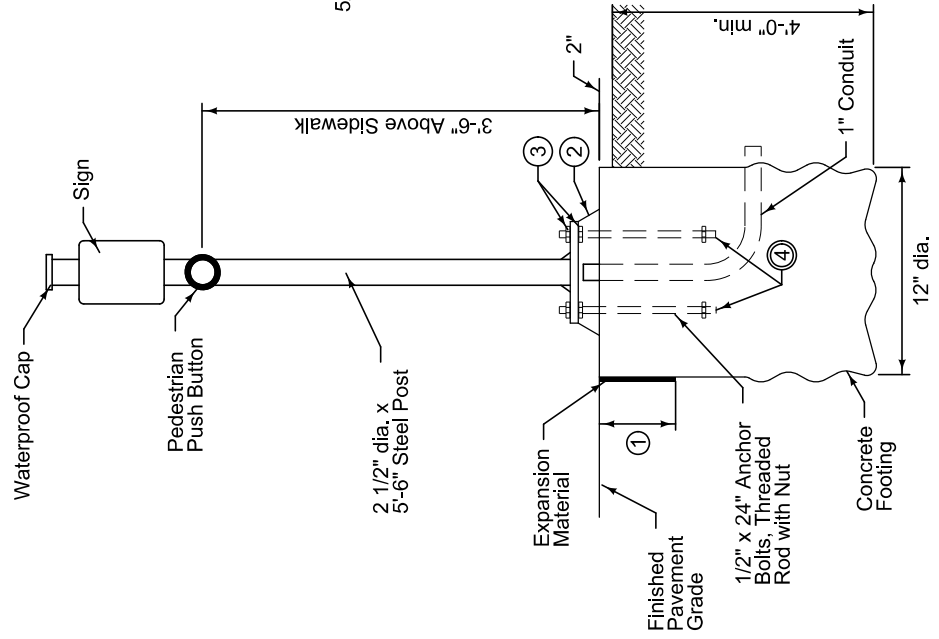

**PEDESTRIAN PUSH BUTTON
POST AND FOOTING**

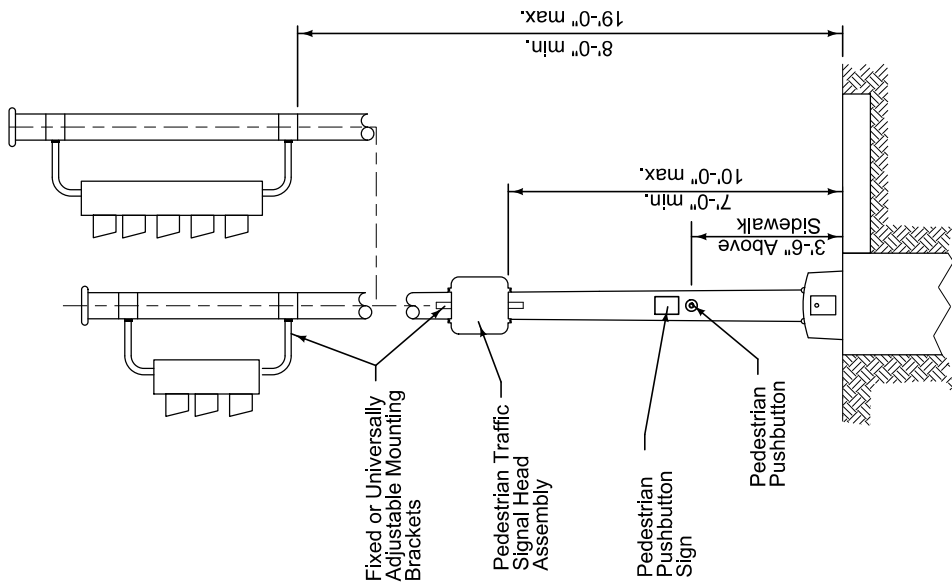

PEDESTAL POLE

	REVISION	10-16-12
	New	
SUDAS 8010.106		SHEET 1 of 1

SUDAS Standard Specifications

PEDESTAL POLE AND
PEDESTRIAN POST DETAILS

